

## KEY FEATURES OF THE GEOTECHNICAL SAFETY PROGRAMME FOR THE AMUAY CLIFFSIDE

T. WILLIAM LAMBE,\* EDMUND K. TURNER,\*  
FRANCISCO SILVA,\*\* and W. ALLEN MARR\*\*\*

### SYNOPSIS

Considerable stability problems were manifest at the Amuay Refinery in Venezuela. However, it was found that a comprehensive long-term solution would have been prohibitively expensive and a more realistic solution was required. This involved the preparation and execution of a geotechnical safety programme which includes the continual monitoring of the slopes affecting the refinery area. After outlining the components of the programme, the paper concentrates on three in particular. These are performance criteria, stability prediction and preventive-remedial measures, and are discussed in relation to the findings so far recorded.

### INTRODUCTION

An earlier paper (LAMBE, SILVA and MARR, 1981) described the instability of the cliffside which bounds the eastern portion of LAGOVEN's Amuay Refinery, Venezuela. The refinery area includes about 4 kilometres of cliff which varies in height from 18 to 22 metres. Figure 1 shows the Amuay Refinery and Figure 2 a general soil profile of the cliffside.

LAGOVEN has constructed refinery structures near the cliffside and has dammed three *quebradas* to make three reservoirs for the storage of fuel oil (FORS). Figure 1 shows the location of three reservoirs, numbered 1, 2 and 3. Each reservoir has a storage capacity of about 10 million barrels.

During the last twenty five years instability of the cliffside has developed and the landslide which occurred in the southeast wall of FORS-3 in December 1976 typifies the slides which have occurred. Figure 3 shows a section of this slide. A vertical crack developed; a wedge, corresponding to an "active wedge" moved downward and away from the cliff; a wedge corresponding to a "passive wedge" moved nearly horizontally with the shear surface near the top of the layer of brown fat clay.

Development of "perched water" above the fat clay triggered the slides. Figure 3 shows piezometer readings above and below the fat clay just prior to

\* Professor of Civil Engineering, Massachusetts Institute of Technology.

\*\* Consulting Geotechnical Engineer, Lexington, Massachusetts.

\*\*\* Research Associate, Department of Civil Engineering, Massachusetts Institute of Technology.

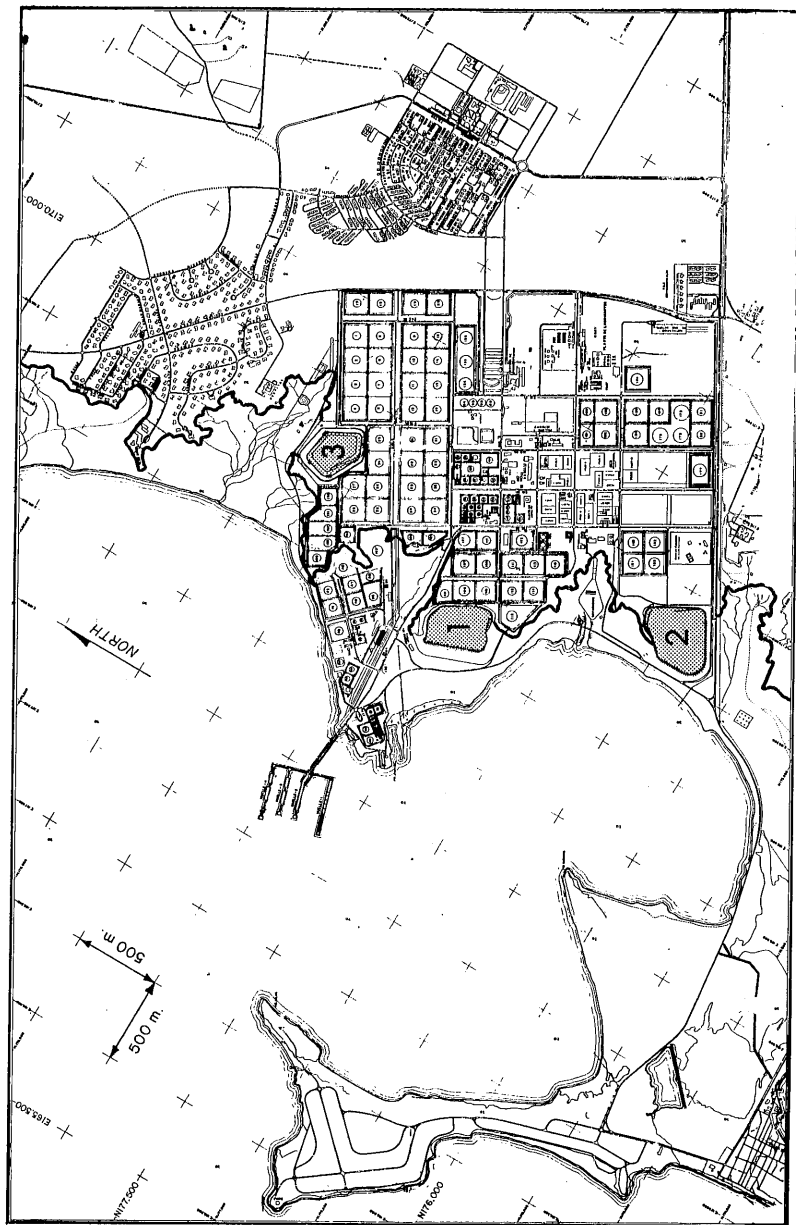

Fig. 1. Industrial and residential areas, Amuay, Venezuela.

AMUAY CLIFFSIDE

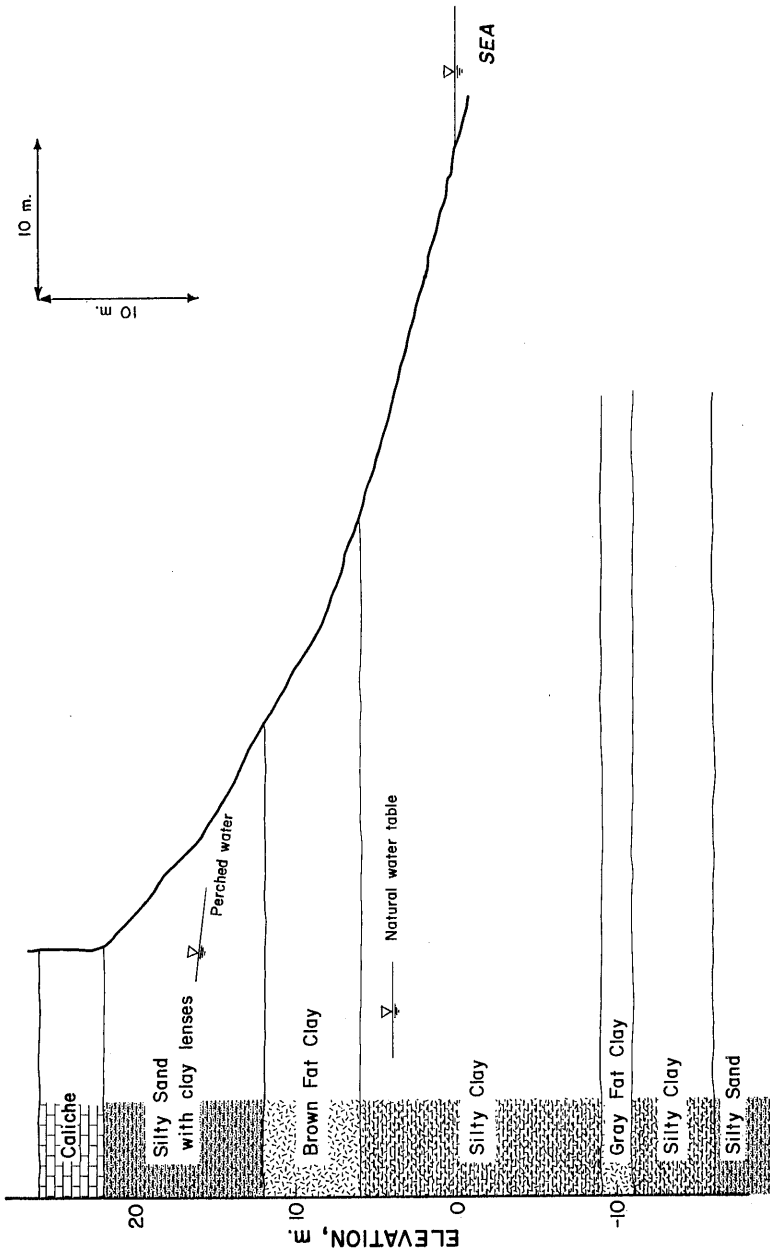

Fig. 2. Amuay soil profile.

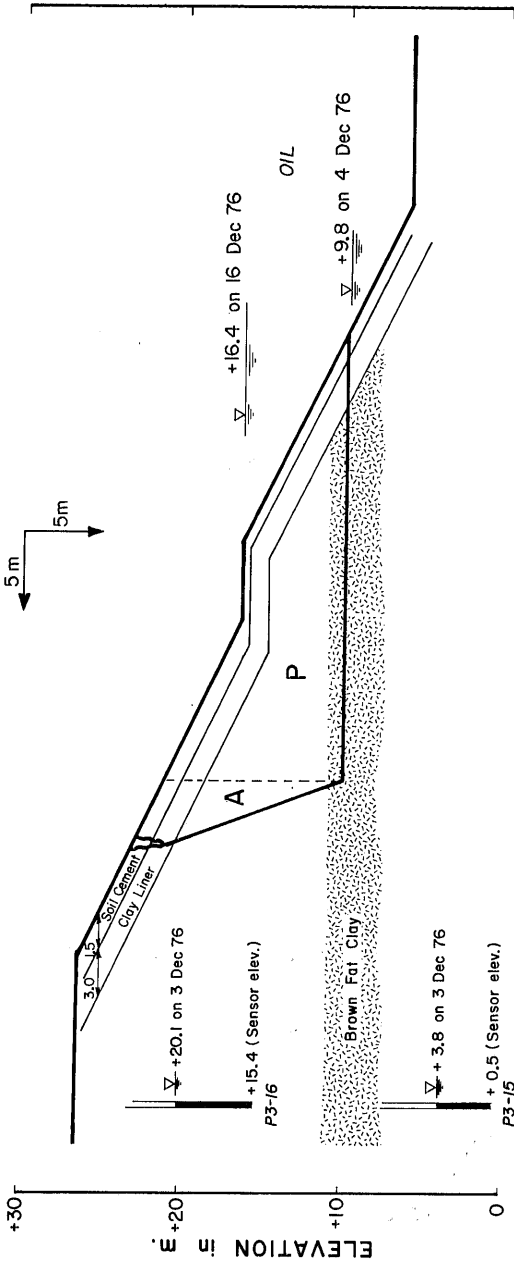

Fig. 3. Landslide-FORS-3, South East Wall, 16 December 1976.

the FORS-3 slide. The development and rise in pore pressure from the perched water causes a drop in effective stress, and thus strength, which, in turn, causes a drop in strength parameters, and a rise in shear stress along a potential landslide shear surface. In spite of attempts to reduce the perched water, the water level has continued to rise. During the last two decades, various measures have been taken by LAGOVEN to stabilize selected regions of the cliffside. However, it is not feasible for LAGOVEN to stabilize once and for all the entire four kilometres of cliffside, since not only would such a "permanent solution" face technical problems but it would also cost hundreds of millions of dollars. Instead a comprehensive Geotechnical Safety Programme has been adopted that rests on:

- (1) identifying cliffside locations where important facilities exist;
- (2) detecting zones in which the degree of stability has fallen to or below the minimum acceptable value; and
- (3) undertaking necessary preventive-remedial measures.

Key features of the Geotechnical Safety Programme for Amuay are now described.

#### COMPONENTS OF SAFETY PROGRAMME

LAMBE, MARR and SILVA (1981) have described comprehensively the Geotechnical Safety Programme and illustrated several components of the programme. The programme contains the following components:

- (1) performance criteria;
- (2) design assessment;
- (3) field measurement system;
- (4) construction assessment;
- (5) surveillance;
- (6) performance evaluations;
- (7) safety assessment;
- (8) preventive-remedial measures;
- (9) contingency plan.

This paper focusses, in particular detail, on three components of the safety programme, namely: performance criteria; stability prediction, a key part of the safety assessment; and preventive-remedial measures.

An initial step in a safety programme consists of establishing performance criteria—i.e. the minimum acceptable level of safety. Appropriate performance criteria depend on various factors including:

- (1) consequences of failure;
- (2) nature of the facility;
- (3) uncertainties in the situation;
- (4) most probable failure mode;
- (5) quality and thoroughness of engineering and construction.

Considering these factors, especially the consequences of a landslide, performance criteria were established for the following three situations:

- (1) FORS dams and abutments;
- (2) FORS walls;
- (3) cliffside.

Figures 4-7 present the performance criteria for these three situations.

#### STABILITY PREDICTION

The tasks facing the geotechnical engineer solving stability problems fall into one of two categories, namely:

- (1) slide analysis;
- (2) stability prediction.

In *slide analysis* the engineer examines an actual slide which has occurred. He knows that the factor of safety equals unity, i.e. the deformations have mobilized the strength of the soil along the failure surface. The geometry of the slide can be measured. LAMBE, SILVA and MARR (1981) presented a procedure to give the correct factor of safety for the slides at Amuay.

A *stability prediction* (Type A Prediction; LAMBE, 1973) consists of determining the level of stability—expressed either as a factor of safety or a probability of failure—for a given slope and a given set of conditions. Stability predictions are used to make a safety assessment and to design preventive-

AMUAY CLIFFSIDE

FORCE DEFORMATION	ASPECT of PERFORMANCE	FAILURE MODE	CRITERIA
STABILITY	 <p><b>BLOWOUT</b></p> <p>Clay Liner Soil Cement floor blanket</p> <p>ELEVATION, m</p> <p>DISTANCE FROM CREST, m</p>	<p>Pore pressures behind the clay liner or the floor blanket cause the rupture of the liner or blanket upon emptying the reservoir.</p> <p>u = pore pressure behind clay liner or floor blanket</p> <p>h = oil elevation in metres</p> <p>f = floor elevation in metres</p>	<p>For points beneath oil: Total Head <math>\leq \frac{h-f}{2} + f</math></p> <p>h-oil elevation f-floor elevation otherwise, <math>a \leq 0</math></p> <p><b>F.S. <math>\geq 1.3</math></b></p>
FLOW	 <p><b>SHEAR SLIDE</b></p> <p>Gatche Brown Fat Clay Brown Fat Clay floor blanket</p> <p>ELEVATION, m</p> <p>DISTANCE FROM CREST, m</p>	<p>Wedge slide of reservoir wall with empty or partially full reservoir. Slide triggered by</p> <ol style="list-style-type: none"> <li>1. Positive pore pressures at the top of the brown fat clay layer (elev. <math>\approx +11</math> m.)</li> <li>2. Positive pore pressures at the bottom of the brown fat clay layer (elev. <math>\approx +7.5</math> m.)</li> </ol> <p>Factor of Safety = <math>\frac{\text{average shear strength on failure surface}}{\text{average shear stress on failure surface}}</math></p>	<p><b>Q = 0</b></p> <p><b><math>d_o \leq 2</math> m.</b></p>
FLOW	 <p><b>SEEPAGE, QUANTITY</b></p> <p>Soil Cement Clay Liner floor blanket</p> <p>ELEVATION, m</p> <p>DISTANCE FROM CREST, m</p>	<p>Oil flow through clay liner or floor blanket</p> <p>Q = total oil seepage per metre of wall or per square metre of floor</p> <p><math>d_o</math> = depth of oil penetration</p>	<p><b>Q = 0</b></p> <p><b><math>d_o \leq 2</math> m.</b></p>

Fig. 4. Performance criteria: FORS Walls, Lagoven, S. A.

FORCE - DEFORMATION	ASPECT of PERFORMANCE	FAILURE MODE	CRITERIA
	<p><b>BLOWOUT</b></p> 	<p>Pore pressures behind the clay liner rupture the liner upon emptying the reservoir.</p> <p>U = pore pressure behind liner</p> <p>h = oil elevation</p> <p>f = floor elevation</p>	<p>For points beneath oil:</p> <p>Total Head <math>\leq \frac{h-f}{2} + f</math></p> <p>h - oil elevation</p> <p>f - floor elevation</p> <p>otherwise,</p> <p>a <math>\leq 0</math></p>
	<p><b>CRACKING</b></p> 	<p>Excessive differential settlement and lateral deformation cause tensile cracks in the embankment or abutments. Three types of cracks can occur</p> <ol style="list-style-type: none"> <li>1. Vertical cracks perpendicular to the dam axis.</li> <li>2. Vertical cracks parallel to the dam axis</li> <li>3. Horizontal cracks along compaction or bedding plane</li> </ol> <p>lc = crack length</p> <p>dc = crack depth</p> <p>wc = crack width</p>	<p><math>d_c \leq 1 \text{ m.}</math></p> <p><math>l_c \leq 10 \times d_c</math></p> <p><math>w_c \leq 1/2 \text{ cm.}</math></p>

Fig. 5. Performance criteria: FORS Dam & Abutments, Lagoven, S. A.

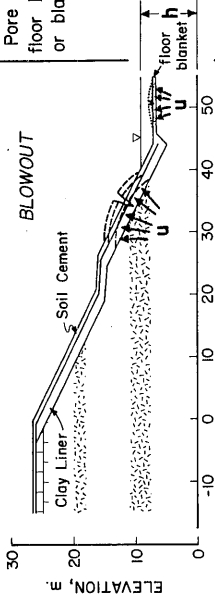
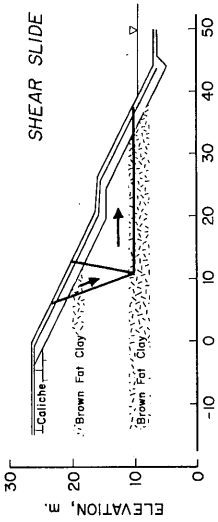
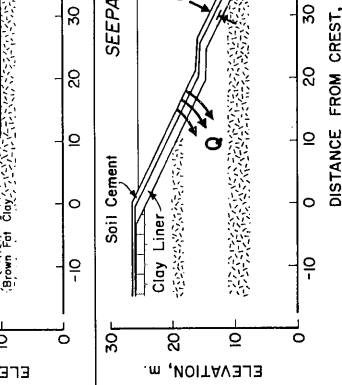

STABILITY	ASPECT of PERFORMANCE	FAILURE MODE	CRITERIA
	<p style="text-align: center;"><b>SHEAR SLIDE</b></p>  <p style="text-align: center;"><b>ABUTMENTS</b></p> 	<p><b>DAM</b></p> <ol style="list-style-type: none"> <li>1. Circular arc slide of downstream portion of dam along the gray fat clay layer.</li> <li>2. Wedge slide of downstream portion of dam with full reservoir. Slide triggered by oil pressure on a potential failure surface.</li> </ol> <p><b>ABUTMENTS</b></p> <p>Wedge Slide of downstream portion of abutment along a brown fat clay layer with full reservoir. Slide triggered by</p> <ol style="list-style-type: none"> <li>1. Positive pore pressures at top of the brown fat clay layer (elev. +11 m.)</li> <li>2. Positive pore pressures at the bottom of the brown fat clay layer (elev. +7.5 m.)</li> <li>3. Oil pressure on a potential failure surface</li> </ol> <p>Factor of Safety = <math>\frac{\text{average shear strength on failure surface}}{\text{average shear stress on failure surface}}</math></p>	<p><b>F.S. <math>\geq</math> 1.5</b></p> <p>with oil in reservoir</p> <p>or</p> <p><b>F.S. <math>\geq</math> 1.3</b></p> <p>with reservoir empty</p>
FLOW	<p style="text-align: center;"><b>SEEPAGE QUANTITY</b></p> 	<ol style="list-style-type: none"> <li>1. Oil flow through clay core or clay liner</li> <li>2. Oil leak through crack or permeable layer in dam or abutment</li> </ol> <p><b>Q</b> = total oil seepage per metre of dam or abutment</p> <p><b>Q<sub>c</sub></b> = total oil seepage through crack or permeable layer</p> <p><b>d<sub>0</sub></b> = depth of oil penetration</p>	<p><b>Q = 0</b></p> <p><b>Q<sub>c</sub> = 0</b></p> <p><b>d<sub>0</sub> <math>\leq</math> 2 m.</b></p>

Fig. 6. Performance criteria: FORS Dam & Abutments, Lagoven, S. A.

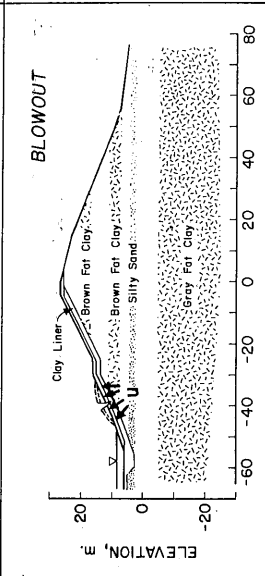
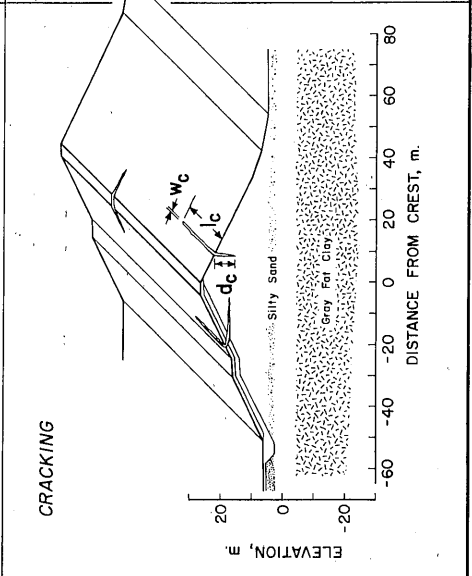

FORCE-DEFORMATION	ASPECT of PERFORMANCE	FAILURE MODE	CRITERIA
	<p><b>CRACKING</b></p>  <p><b>DIFFERENTIAL SETTLEMENT</b></p>	<p>Deformations within the cliffside soil mass that cause tensile cracks near the crest.</p> <p>Deformations within the cliffside soil mass that result in differential settlement of the crest.</p>	<p>no refinery facilities exist within 100 m. or less</p> <p>refinery facilities exist within 100 m. of crest or toe</p> <p><math>d_c \leq 2 \text{ m.}</math>  <math>d_c \leq 1 \text{ m.}</math>  <math>l_c \leq 25 \times d_c</math>  <math>l_c \leq 10 \times d_c</math>  <math>w_c \leq 2 \text{ cm.}</math>  <math>w_c \leq 1/4 \text{ cm.}</math>  <math>p \leq 4 \text{ cm.}</math>  <math>p \leq 1/2 \text{ cm.}</math></p>
STABILITY	<p><b>SHEAR SLIDE</b></p>  <p><b>LOW EFFECTIVE STRESS</b></p> 	<ol style="list-style-type: none"> <li>1. Wedge slide of cliffside section through a fat clay layer triggered by high pore pressures in the clay due to a rising perched water table.</li> <li>2. Slides in rubble material deposited in erosion channels or "quebrados" during the refinery construction or during natural cliffside regression process. The failure surface will almost surely develop along the rubble-natural soil interface after surface run off and perched water trickle downslope along the interface.</li> <li>3. Deep seated slide along a fat clay layer triggered by the excavation of material at the toe of the slope</li> </ol> <p>Perched water table causes enough pore pressure near the toe of a slope to reduce the effective stresses sufficiently to develop unstable conditions at nearby foundations.</p>	<p>F.S. <math>\geq 1.1</math></p> <p>F.S. <math>\geq 1.3</math>          or          F.S. <math>\geq 1.5</math>          if a new refinery facility lies within 25 metres of the crest or toe</p> <p><math>\bar{\sigma}_z \geq \frac{2}{3} z \gamma_w</math>  <math>\alpha \leq \frac{2}{3}</math></p>
FLOW	<p><b>TRANSPORT OF SOIL PARTICLES BY FLUID FLOW</b></p>  <ol style="list-style-type: none"> <li>1. Erosion</li> <li>2. Piping</li> </ol>	<ol style="list-style-type: none"> <li>1. Transport of soil by surface runoff results in the formation of erosion features such as gullies and "quebrados". Excessive erosion generally decreases the stability of the cliffside.</li> <li>2. Excessive exit gradients at perched water breakouts allow internal erosion of fine soil particles. Unless corrected, continued piping could undermine foundations on top of the cliffside.</li> </ol>	<p><math>\bar{\sigma}_z \geq z \gamma_w</math>  <math>\alpha \leq 0</math></p> <p>Gullies less than 1/2 m. wide, 1/4 m. deep, 2 m. long</p> <p>Gullies less than 1 m. wide, 1 m. deep, 10 m. long</p> <p>Clear water at breakouts</p> <p>Clear water at breakouts</p>

Fig. 7. Performance criteria: cliffside, Lagoven, S. A.

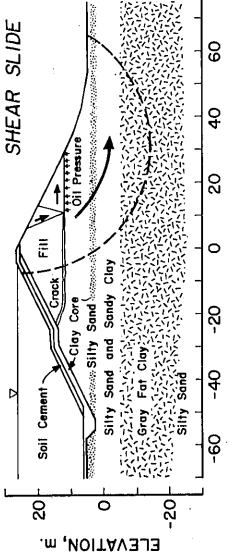
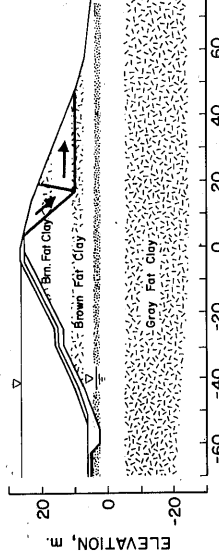
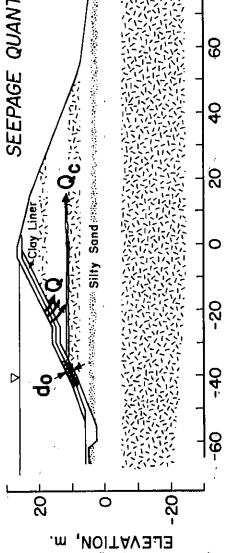
remedial measures. In the Amuay Geotechnical Safety Programme an annual safety assessment is made of every key slope, and to make a safety assessment a stability prediction must be made. Since experience at Amuay has indicated that two years are needed to design and implement a remedial measure, the stability prediction considers an existing slope for a "future condition", i.e. two years from the time of the assessment.

For any slope not meeting performance criteria, preventive measures are designed, and, accordingly, for any failed slope, remedial measures. A design life of twenty five years is assumed by LAGOVEN. Thus, to design preventive-remedial measures a stability prediction for an existing or a future slope for conditions twenty five years in the future must be made.

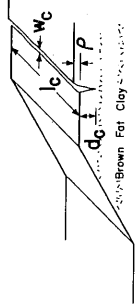
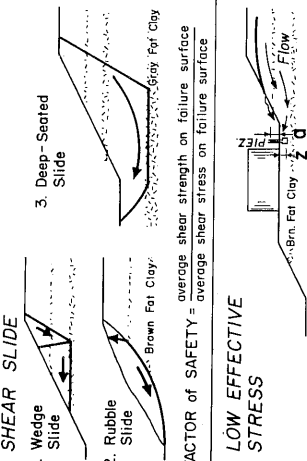
In the LAGOVEN Geotechnical Safety Programme, *stability prediction* has constituted a task of much more importance—and, unfortunately, much more difficulty—than a *slide analysis*. Stability prediction has proved more difficult than slide analysis because of the following characteristics:

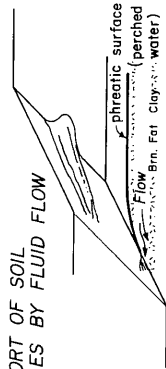
- (1) the engineer must predict—not measure—the geometry of the critical soil mass;
- (2) the engineer must predict the environmental condition—especially pore water regime—for the time in the future for which the factor of safety is desired;
- (3) the engineer must predict the strength parameters and the degree of strength mobilization for the various soils along the critical shear surface;
- (4) the engineer must postulate the likely events which could lead to failure.

For each stability prediction, the critical section is selected using:

- (1) observed geometry of actual slides at Amuay;
- (2) the physical characteristics of the section under consideration especially the location of the fat clay and any external load near the slope;
- (3) analyses which seek the surface having the minimum calculated factor of safety.

Figure 8 illustrates the steps in locating the surface having the minimum calculated factor of safety. Figure 9 indicates the procedure for selecting the appropriate clay strength for a stability prediction. Considering the stage

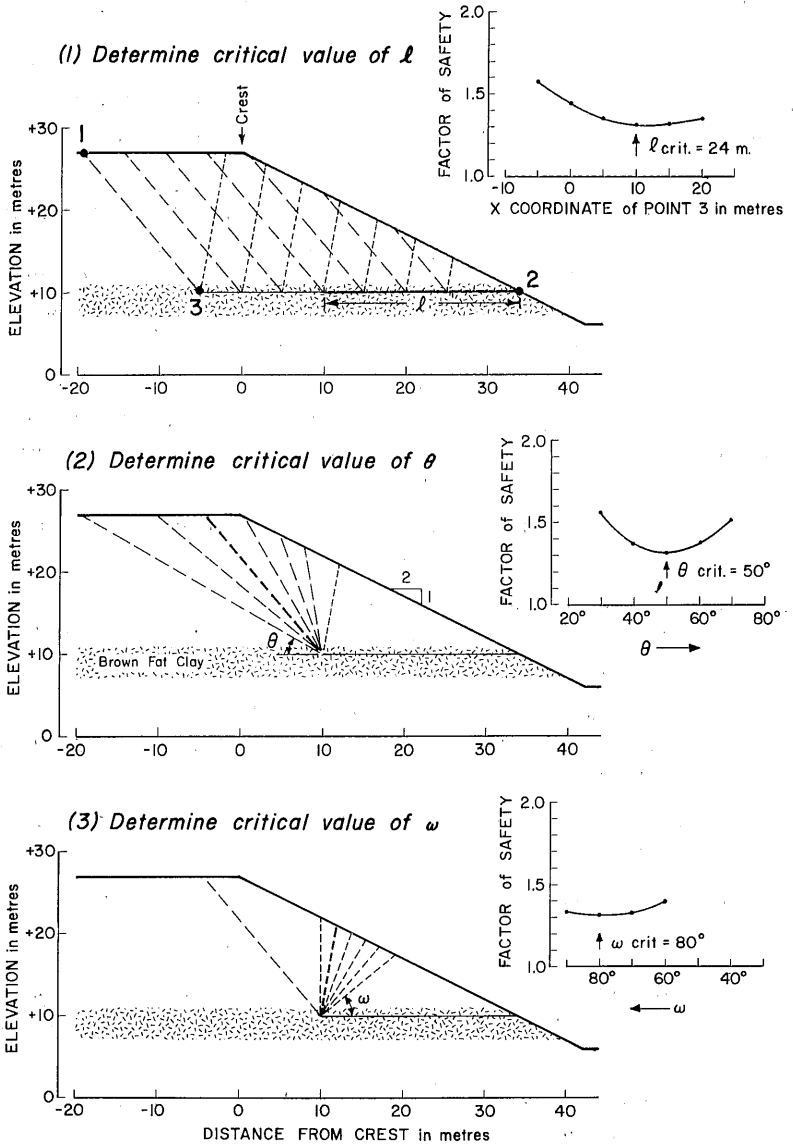
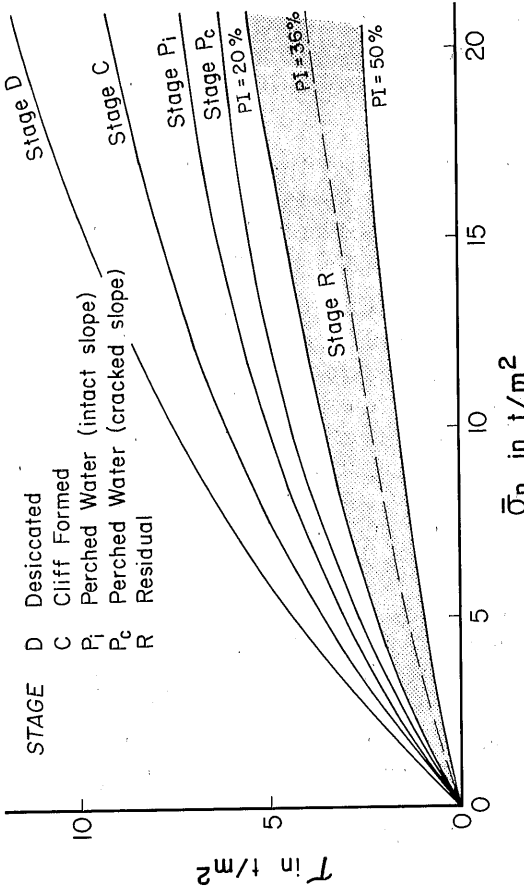

Fig. 8. Locating the critical failure surface.

$P_c$  strength, Pore pressure at top of Brown Fat Clay =  $4 \text{ t/m}^2$  at-10m from crest (see Fig.10).



CRITERIA FOR STRENGTH SELECTION

Stage at Present + 2 years	Stage at end of Design Life	Applicable Strength	
		Assessment	Design
D	D	D	use C
	C	D	C
	Pi	D	Pi
	Pc	D	Pc
	R	D	R
C	C	C	C
	Pi	C	Pi
	Pc	C	Pc
	R	C	R
Pi	Pi	Pi	Pi
	Pc	Pi	Pc
	R	Pi	R
Pc	Pc	Pc	Pc
	R	Pc	R
R	R	R	R

Fig. 9. Clay strength selection for stability prediction.

of the clay at the time of stability prediction, the stage of the clay for the desired time in the future is predicted. LAMBE, SILVA and MARR (1981) described the stress stages of the fat clay and the method used to obtain the strength line for each stage.

Sufficient field evidence is not available to justify trying to use some procedure which considers "progressive action". The stability prediction is therefore made for the situation of equal mobilization of strength in all soils, i.e. the same factor of safety in the silty sand and the fat clay.

Figure 10 presents the procedure for selecting the pore pressure for a stability prediction. The pore pressure distribution used in the stability prediction comes from extrapolating an actual measured or a predicted value of total head at a piezometer 10 metres away from the crest of the slope using Figure 10. Use of this "steady state" pore pressure has been found to give the correct factor of safety for an actual landslide. Using the pore pressure for steady state seepage prior to a slide for the prediction of a slide is a matter of concern since this procedure neglects any excess pore pressure developed by straining associated with the landslide.

Figure 11 presents charts for making a stability prediction, and these charts are used for an initial assessment of stability. If the factor of safety obtained from the stability charts exceeds the value allowed by the performance criteria by 20% or more the results obtained from the charts are used. If the chart solution does not exceed the performance criteria by 20%, the slope is further investigated using analyses with detailed conditions.

#### PREVENTIVE-REMEDIAL MEASURES

In the Geotechnical Safety Programme, the degree of stability for a given slope is determined and then recommendations given for appropriate action. Figure 12 relates "degree of stability" and "required action" for the earth dams and especially the abutments of the oil storage reservoirs. The term "preventive measure" is used to cover actions (e.g. drainage from wells above the slope) taken away from the slope in question, whereas the term "remedial measure" is used to involve an action (e.g. flatten the slope) on the slope itself.

Figure 13 shows a free body for the passive wedge of a potential slide. Using Figure 13, the possible means of improving stability of a slope have been considered. In general, stability has been improved by taking measures which do one of the following:

## AMUAY CLIFFSIDE

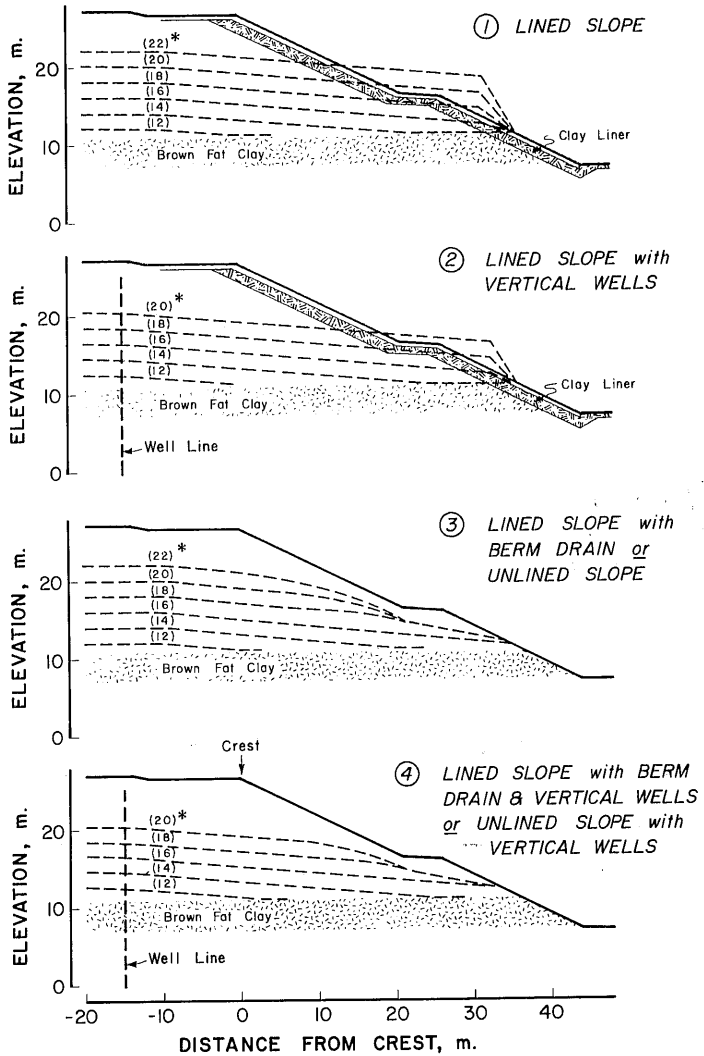

\* dashed lines give Total head distribution at top of Brown Fat Clay for total head = (#) @ -10m. from crest

**Fig. 10. Selection of pore pressure for stability prediction  
Stability analysis interim guidelines.**

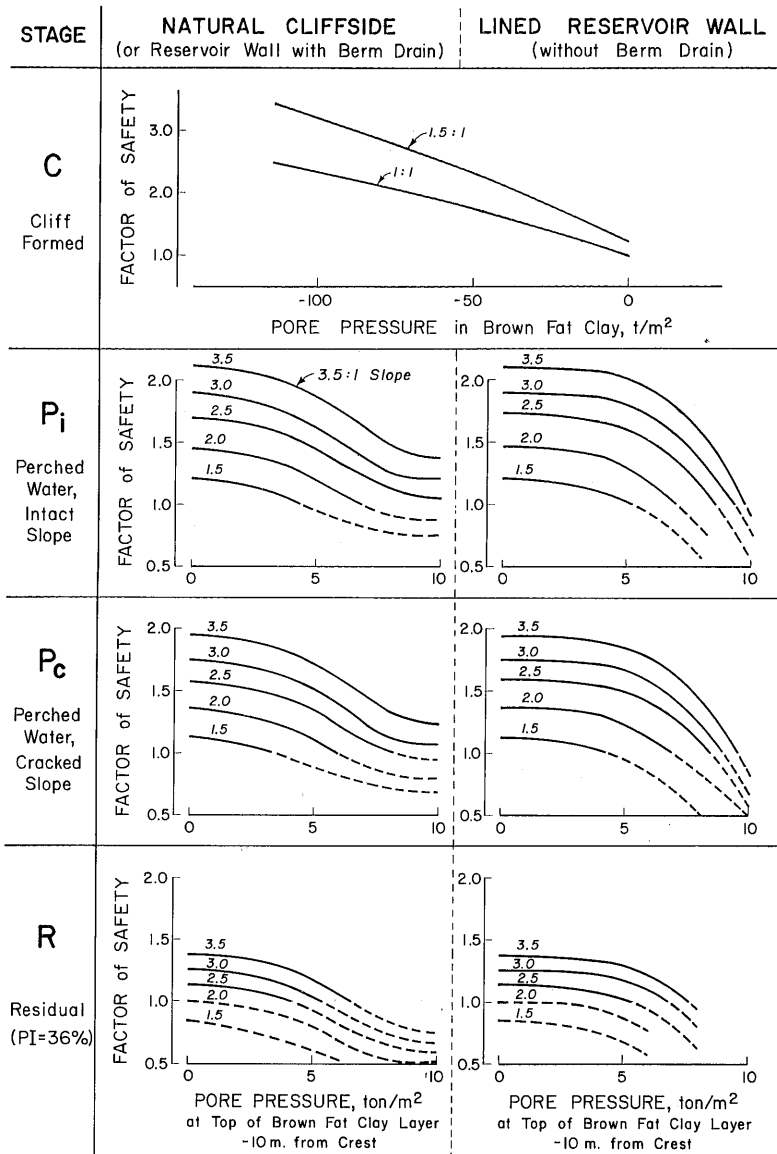

Fig. 11. Stability charts.



AMUAY CLIFFSIDE

- (1) reduce the net actuating force;
- (2) increase the net resisting force;
- (3) combine 1 and 2.

When considering the reduced net actuating force, the following possibilities exist:

- (1) reduce  $U_L$  (install surface drainage uphill of the slope (install vertical drainage);
- (2) reduce  $\bar{P}$  (reduce any surcharge on the cliff near the crest of the slope, strengthen the soil in the active wedge);
- (3) reduce  $G$  (remove some of the passive wedge, replace some of the passive wedge with a material of lower unit weight).

Net resisting force can be increased by:

- (1) increasing the strength parameters of the soil (chemical means, electrical means, temperature, replace weak soil with stronger soil, overload);
- (2) reducing  $U_s$  (install vertical or horizontal drainage);
- (3) increasing  $O$  (raise the level of oil in the reservoir);
- (4) increasing  $R$  (construct berm, install tie backs, install retaining wall).

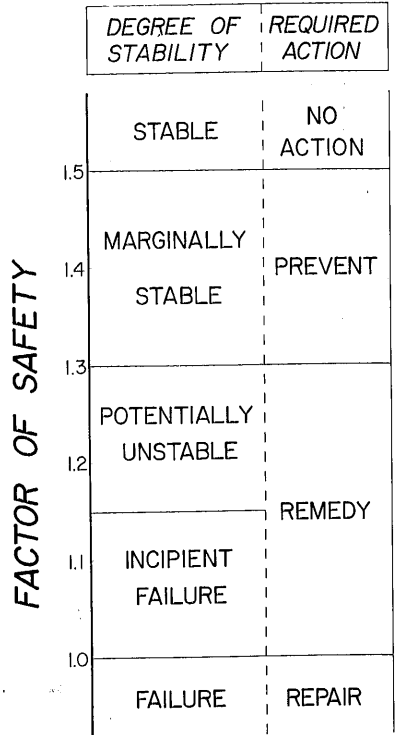
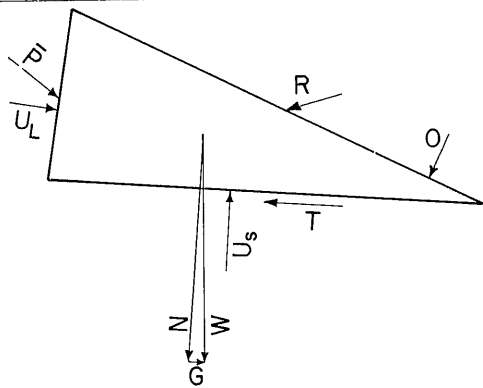
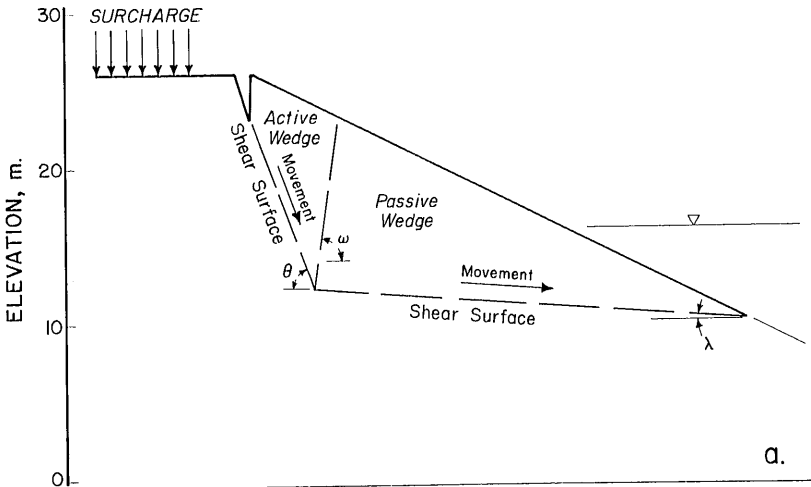

Fig. 12. Required action as function of degree of stability.

For the stability problem at Amuay, most of the possible measures for increasing stability have been investigated and many applied. The following sections describe several procedures successfully used. In general, as in many foundation problems, the most effective stabilizing technique, either alone or in conjunction with another technique, consists of *drainage*.



ACTUATING FORCES

- $U_L$  = Lateral Water Force
- $\bar{P}$  = Lateral Soil Force, including effect of Surcharge
- $G$  = Gravity Effect =  $W \sin \lambda$

RESISTING FORCES

- $T$  = Shear Resistance
- $O$  = Fluid (Oil) Force
- $R$  = Resisting Force from Berm, Tie, etc.

c.

Fig. 13. Landslide forces.

# AMUAY CLIFFSIDE

## SLIDE PREVENTION AT PIPE BAND

Rising pore pressures in the perched water layer caused a deteriorating stability situation at the pipe band. Figure 14a shows two sections of the pipe band slope having a low degree of stability, and Figure 14b and Figure 15 show elevation views of these two sections.

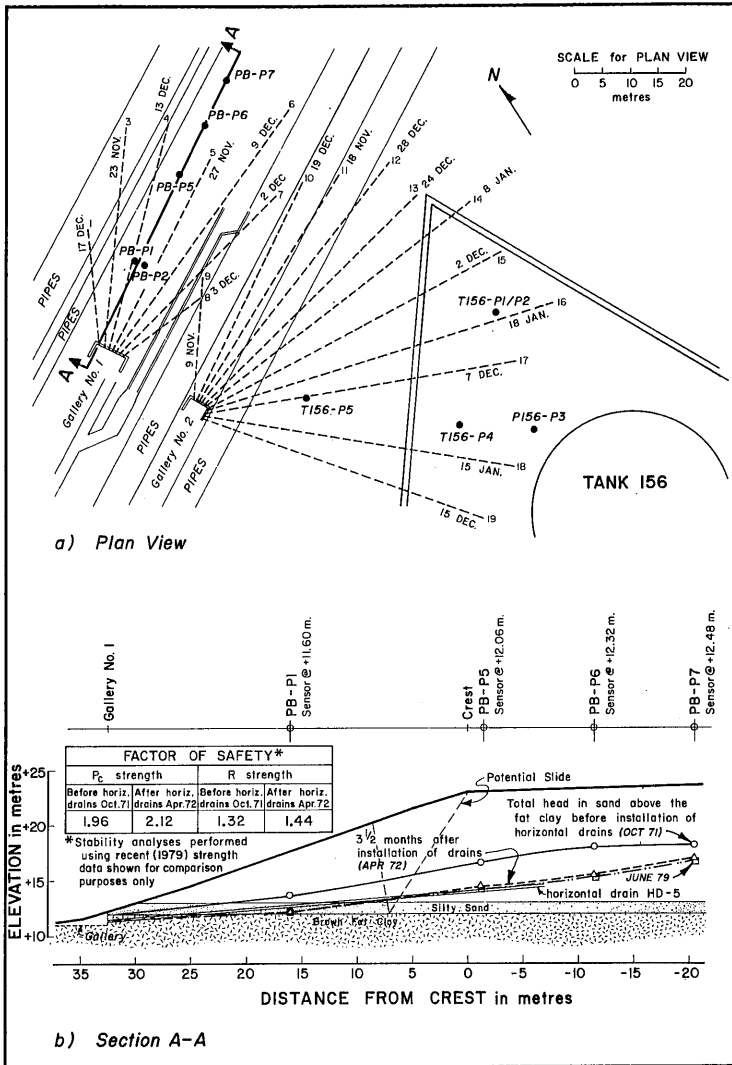

Fig. 14. Cliffside stabilization with lateral drainage.

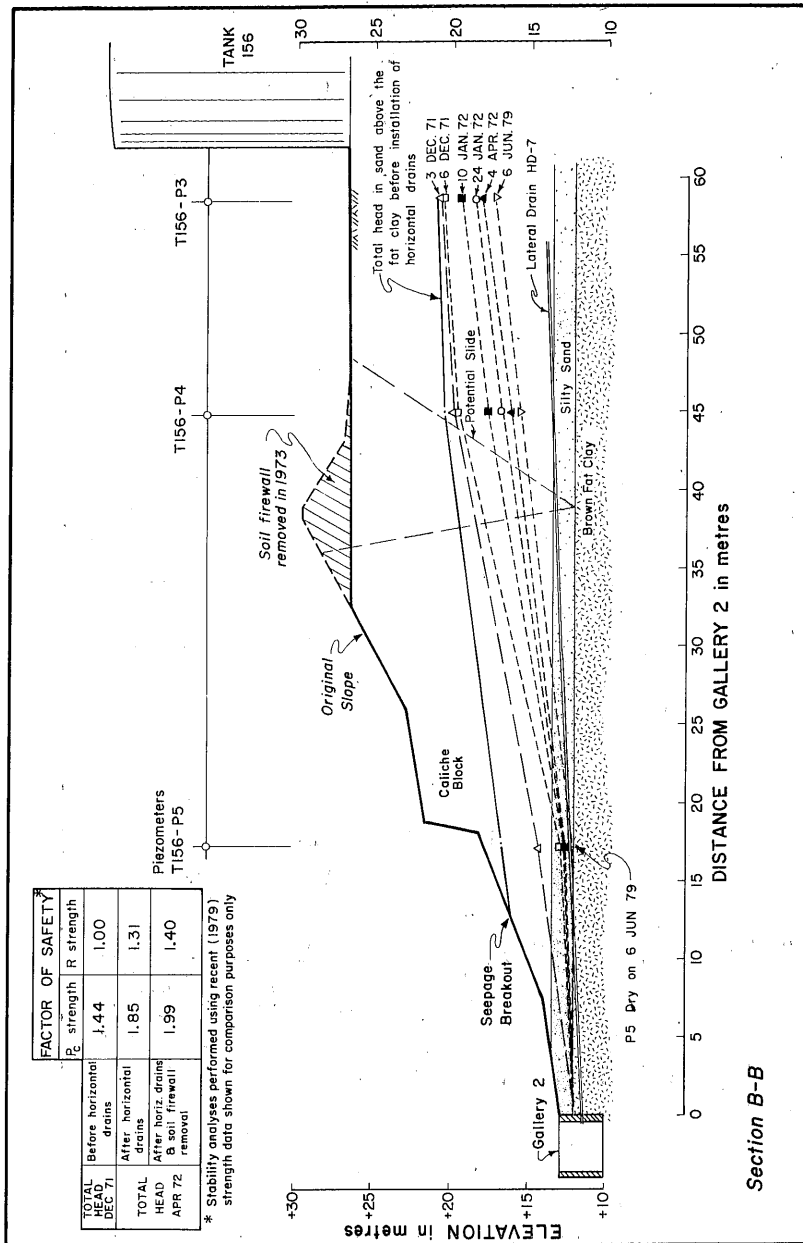

Fig. 15. Cliffside stabilization by unloading and lateral drainage.

## AMUAY CLIFFSIDE

In the late 1960's rising pore pressures in the pipe band area and the development of surface cracks led to the conclusion that the strength of the fat clay resisting a landslide was approaching the residual value. Stability predictions using residual strength parameters gave a factor of safety of 1.3 for Section A-A and 1.0 for Section B-B. The stability predictions indicated that within a few years Section A-A would have a factor of safety below the allowable minimum of 1.3 (see Figure 7) and that a landslide might well occur at Section B-B. Measures were therefore designed and executed to increase the factor of safety at each section to the 1.3 required in the performance criteria:

As indicated in Figure 14b, LAGOVEN installed 18 lateral drains at the pipe band. These lateral drains intercepted a layer of relatively pervious silty sand overlying the brown fat clay. The total head data plotted in Figures 14b and 15 show the magnitude and rate of total head drop. The pore pressure drop at Section A-A, effected by the lateral drains, increased the factor of safety to 1.4, a value greater than the minimum permissible value of 1.3.

Figure 15 shows factors of safety for Section B-B after the lateral drains reduced the total heads. The figure also shows the stability improvement effected by removing some of the slope and especially the fire wall. The safety factors shown in Figure 15 indicate that drainage alone improved the stability of Section B-B to the level required by the performance criteria. At the time the remedial measures for Section B-B were designed there was little confidence that the lateral drains would work as well as they did and therefore removal of the fire wall was requested as well as drainage at Section B-B.

LAGOVEN's experience with slope stabilization at the pipe band has shown that lateral drainage can dramatically lower total heads and thereby improve the degree of slope stability.

## SLIDE PREVENTION AT FORS-1

Rising pore pressures near the north abutment of FORS-1 caused a serious deterioration in stability. A landslide on the outside of the north abutment could have catastrophic effects, if it occurred when FORS-1 stored a large amount of fuel oil. Stability predictions for the outside of the north abutment of FORS-1 indicated a factor of safety of about 1.2, a value far below the minimum permitted by the performance criteria (1.5). Figure 16 shows a plan view of part of the north abutment of FORS-1 and an elevation view of Section A-A. Section A-A had the lowest degree of stability at the north

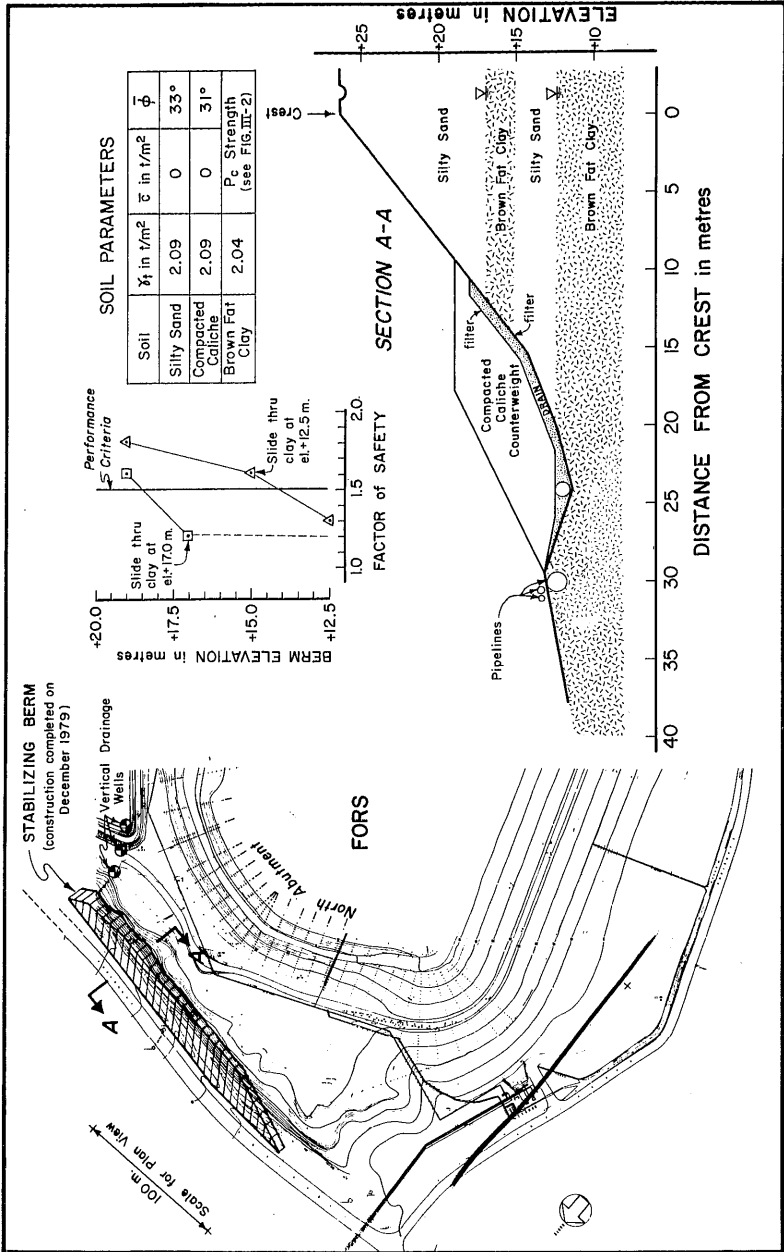

Fig. 16. Cliffside stabilization with a counterweight.

## AMUAY CLIFFSIDE

abutment. Figure 16 also gives predicted factor of safety as a function of elevation of the crest of the stabilizing berm. As the predicted safety factors indicate, a berm extending up to elevation +18.5 (along with drainage wells) should increase the factor of safety at the critical section of the north abutment to a value of 1.5, i.e. that required by the performance criteria. During 1979 LAGOVEN constructed the stabilizing berm.

### PREVENTIVE-REMEDIAL WORK AT FORS-3

Rapidly rising pore pressures in the perched water caused concern for stability of the natural slope of FORS-3. Stability predictions made in the early 1970's indicated factors of safety considerably below those permitted by the performance criteria. In fact, stability predictions indicated the likelihood of a landslide occurring in the northeast wall of FORS-3. Figure 17 shows Section B-B, where a slide had been predicted. In hopes of preventing the landslide a system of vertical wells which would permit the perched water to flow through the layer of fat clay were designed and installed and the typical well installation is indicated in Figure 17. However, before LAGOVEN had installed the vertical drainage wells, a landslide occurred near Section A-A.

Figure 17 shows elevation views of Sections A-A and B-B. These elevation views also indicate the distribution of total head before well installation and the predicted distribution of total head after well installation. A berm drain in Section B-B helped lower total heads near the face of the slope at Section B-B. As calculated factors of safety presented in Figure 17 indicate, the drainage system installed in the natural hillside of FORS-3 should prevent further landslides.

### SUMMARY AND CONCLUSIONS

Much of the cliffside bordering LAGOVEN's Amuay Refinery, Venezuela, exists in an unstable condition. Perched water arising from activities from within the refinery has developed above a layer of fat clay which acts as a seal. Rising pore pressures from the development of perched water has triggered landslides which occur mostly through the fat clay. During the last two decades various measures have been taken to stabilize selected regions of the cliffside. High costs preclude a "permanent solution" to potential landslides for the entire cliffside.

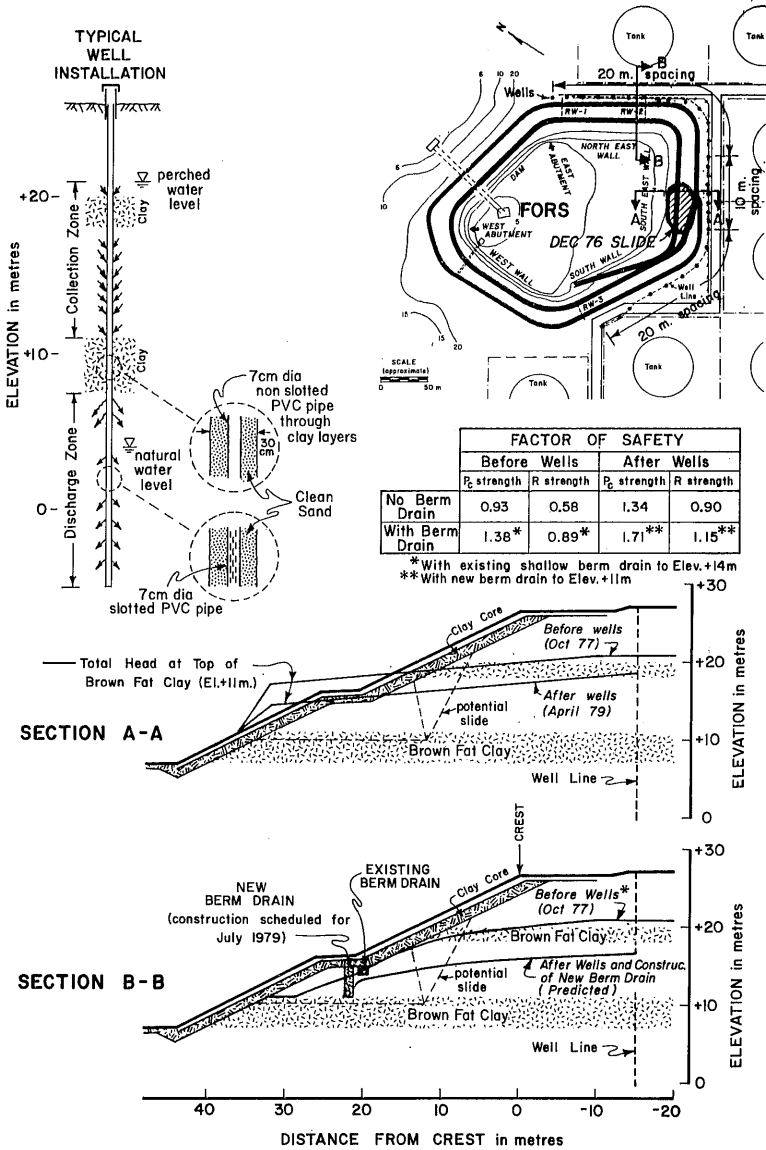

Fig. 17. Cliffside stabilization with drainage.



## AMUAY CLIFFSIDE

A Comprehensive Geotechnical Safety Programme has been adopted which is based on:

- (1) identifying cliffside locations where important facilities exist nearby;
- (2) detecting zones where the degree of stability has fallen to or below the minimum acceptable values;
- (3) undertaking necessary preventive and remedial measures.

Evaluated experience at Amuay has revealed several successful means of slope stabilization including unloading, counterweight construction and drainage. Drainage alone or in conjunction with other techniques has proved the most effective stabilization technique. Experiences at Amuay have emphasized the general necessity of surveillance, performance evaluation and periodic safety assessment.

## REFERENCES

- LAMBE, T. W. (1973). Predictions in Soil Engineering, 13th Rankine Lecture, *Geotechnique*, Vol. 23, No. 2, June, pp. 149-202.
- LAMBE, T. W. and MARR, W. A. (1979). Stress Path Method: Second Edition, *Journal of the Geotechnical Engineering Division*, ASCE, Vol. 105, No. GT6; Proc. Paper 14655, June, pp. 727-738.
- LAMBE, T. W., MARR, W. A. and SILVA, F. (1981). Safety of a Constructed Facility (Geotechnical Aspects), *Journal of the Geotechnical Engineering Division*, ASCE, Vol. 107, No. GT3; Proc. Paper 16107, pp. 339-352, March.
- LAMBE, T. W., SILVA, F. and MARR, W. A. (1981). The Instability of the Amuay Cliffside, Accepted for publication in the *Journal of the Geotechnical Engineering Division*, ASCE, November.